

ETEREA PORTABLE

E9B151- -

base number Color Finish
 Temperature Options

- To build a product code in our configurator select the specify button on the base model # product page
- To build a manual product code on this datasheet choose from the options listed below in blue font and add the suffix to the base model #

GENERAL

Series: Eterea
 Brand: Platek
 Division: Exterior
 Mounting Type: Portable
 Mounting Location: Floor
 Subcategory: Floor

PHYSICAL

Shape: Rectangle
 Length (mm): 216
 Length (in): 8 1/2
 Width (mm): 216
 Width (in): 8 1/2
 Height (mm): 455
 Height (in): 17 15/16
 Light Distribution: Direct
 Weight (kg): 6.3
 Weight (lbs): 13.8
 Diffuser: White Tempered Glass
 Fixture Finish: WHI / ANT / COR
 Holder Finish: Chrome
 Fixture Material: Stainless Steel
 Cable Details: Supplied with one power supply cable 5m in length
 Upon Request: Bolt Down

ELECTRICAL

Lamp Type: LED
 Input Wattage (W): 17.5
 Total Output Wattage (W): 16.5
 Dimming: Non-Dimmable
 Input Voltage (V): 120

LED

Color Temperature (°K): 3000 / 4000
 Max. Delivered Lumen (lm): 735 / 765
 Nominal Lumen (lm): 1550 / 1612
 CRI: >80 CRI
 Lamp Life (hrs): 60000

OPTICAL

Optic°: 114

RATINGS AND CERTIFICATIONS

Certified By: Certified for North American Standards
 IP rating: IP65
 IK Rating: IK08
 Bug Rating: B0 U0 G0
 Upon Request: Higher Maximum Ambient Temperature



ETEREA PORTABLE

E9B151-

| | |
|-----------|-------|
| PROJECT | _____ |
| TYPE | _____ |
| SPECIFIER | _____ |
| QUANTITY | _____ |
| DATE | _____ |

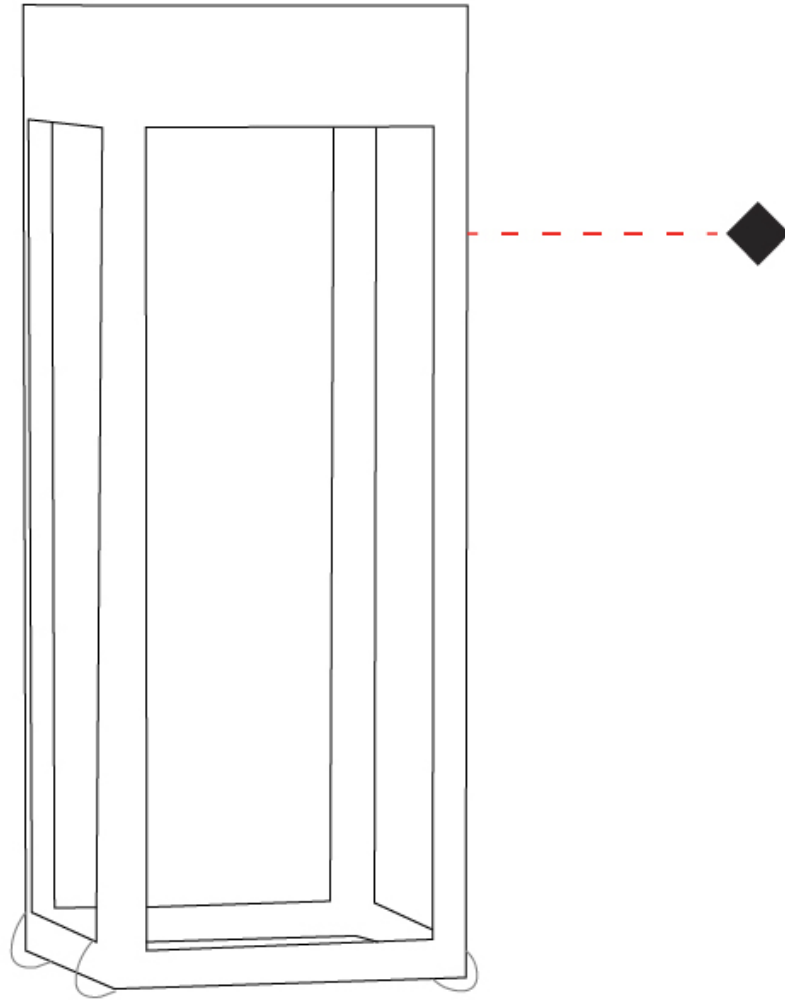

E

ETEREA PORTABLE

E9B224-

base number Finish
Options

- To build a product code in our configurator select the specify button on the base model # product page
- To build a manual product code on this datasheet choose from the options listed below in blue font and add the suffix to the base model #

GENERAL

Series: Eterea
Brand: Platek
Division: Exterior
Mounting Type: Portable
Mounting Location: Table
Subcategory: Battery Operated

PHYSICAL

Shape: Rectangle
Length (mm): 150
Length (in): 5 ⁷/₈
Width (mm): 150
Width (in): 5 ⁷/₈
Height (mm): 300
Height (in): 11 ¹³/₁₆
Light Distribution: Direct
Weight (kg): 1.8
Weight (lbs): 4
Screws: No visible screws
Diffuser: Frosted Methacrylate
Fixture Finish: [ANT](#) / [BLK](#) / [BRZ](#) / [COR](#) / [RSB](#) / [WHI](#)
Fixture Material: Stainless Steel
Cable Details: Supplied with one Micro USB power supply cable 1.2m in length
Upon Request: Bolt Down

ELECTRICAL

Lamp Type: LED
Input Wattage (W): 4.5
Total Output Wattage (W): 4.5
Dimming: Non-Dimmable
Input Voltage (V): 120

LED

Number of LEDs: 1
Color Temperature (°K): 3000
Max. Delivered Lumen (lm): 275
Nominal Lumen (lm): 450
CRI: >90 CRI
Lamp Life (hrs): 60000

OPTICAL

Optic°: 100

RATINGS AND CERTIFICATIONS

Certified By: Certified for North American Standards
IP rating: IP65
IK Rating: IK07
Bug Rating: B0 U0 G0
Upon Request: Higher Maximum Ambient Temperature

| | |
|-----------|-------|
| PROJECT | _____ |
| TYPE | _____ |
| SPECIFIER | _____ |
| QUANTITY | _____ |
| DATE | _____ |

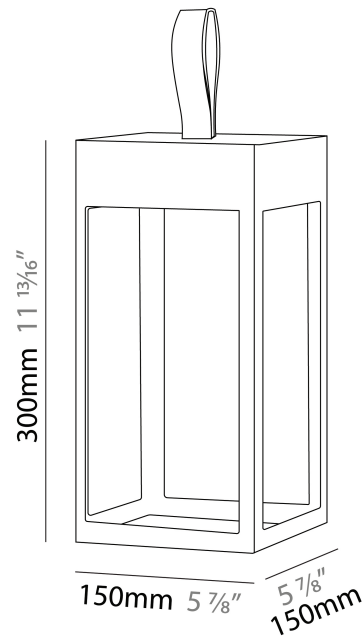

ETEREA PORTABLE

E9B224-

PROJECT _____

TYPE _____

SPECIFIER _____

QUANTITY _____

DATE _____



PROJECT _____
 TYPE _____
 SPECIFIER _____
 QUANTITY _____
 DATE _____

ETEREA PORTABLE

E9B268-

base number _____
 Finish _____
 Options _____

- To build a product code in our configurator select the specify button on the base model # product page
- To build a manual product code on this datasheet choose from the options listed below in blue font and add the suffix to the base model #

GENERAL

Series: Eterea _____
 Brand: Platek _____
 Division: Exterior _____
 Mounting Type: Portable _____
 Mounting Location: Table _____
 Subcategory: Battery Operated _____

PHYSICAL

Shape: Rectangle _____
 Length (mm): 216 _____
 Length (in): 8 ½ _____
 Width (mm): 216 _____
 Width (in): 8 ½ _____
 Height (mm): 455 _____
 Height (in): 17 15/16 _____
 Light Distribution: Direct _____
 Weight (kg): 2.80 _____
 Weight (lbs): 6.17 _____
 Screws: No visible screws _____
 Diffuser: Frosted Methacrylate _____
 Fixture Finish: [ANT](#) / [BLK](#) / [BRZ](#) / [COR](#) / [RSB](#) / [WHI](#) _____
 Fixture Material: Stainless Steel _____
 Cable Details: Supplied with one Micro USB power supply cable 1.2m in length _____
 Upon Request: Bolt Down _____

ELECTRICAL

Lamp Type: LED _____
 Input Wattage (W): 4.5 _____
 Total Output Wattage (W): 4.5 _____
 Dimming: Non-Dimmable _____
 Input Voltage (V): 120 _____

LED

Number of LEDs: 1 _____
 Color Temperature (°K): 3000 _____
 Max. Delivered Lumen (lm): 275 _____
 Nominal Lumen (lm): 450 _____
 CRI: >90 CRI _____
 Lamp Life (hrs): 60000 _____

OPTICAL

Optic°: 100 _____

RATINGS AND CERTIFICATIONS

Certified By: Certified for North American Standards _____
 IP rating: IP65 _____
 IK Rating: IK07 _____
 Bug Rating: B0 U0 G0 _____
 Upon Request: Higher Maximum Ambient Temperature _____

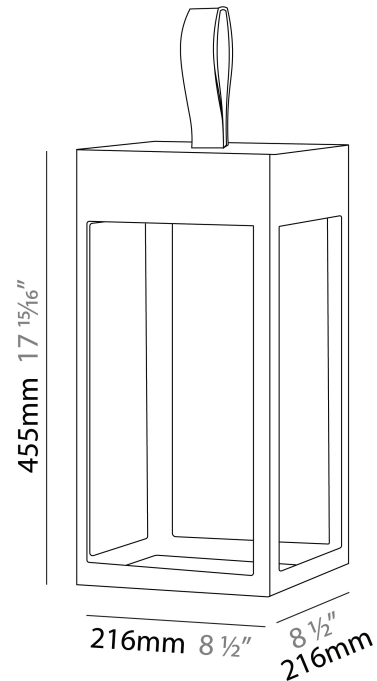

ETEREA PORTABLE

E9B268-

PROJECT _____

TYPE _____

SPECIFIER _____

QUANTITY _____

DATE _____

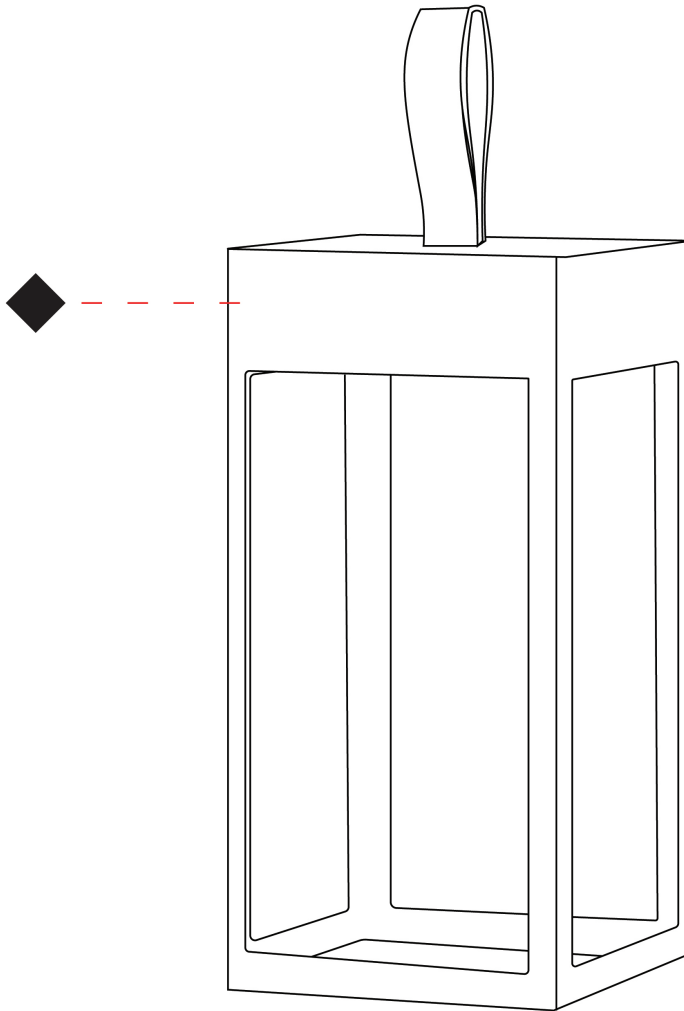

| | |
|-----------|-------|
| PROJECT | _____ |
| TYPE | _____ |
| SPECIFIER | _____ |
| QUANTITY | _____ |
| DATE | _____ |

ETEREA SURFACE

E9W609- _____ - _____
 base number Color Finish
 Temperature Options

- To build a product code in our configurator select the specify button on the base model # product page
- To build a manual product code on this datasheet choose from the options listed below in blue font and add the suffix to the base model #

GENERAL

Series: Eterea
 Brand: Platek
 Division: Exterior
 Mounting Type: Surface
 Mounting Location: Wall
 Subcategory: Wall Effect

PHYSICAL

Shape: Rectangle
 Length (mm): 216
 Length (in): 8 1/2
 Width (mm): 216
 Width (in): 8 1/2
 Height (mm): 455
 Height (in): 17 15/16
 Light Distribution: Direct
 Weight (kg): 6.1
 Weight (lbs): 13.4
 Diffuser: White Tempered Glass
 Fixture Finish: WHI / ANT / COR
 Holder Finish: Chrome
 Fixture Material: Stainless Steel
 Cable Details: Supplied with one power supply cable 5m in length

ELECTRICAL

Lamp Type: LED
 Input Wattage (W): 17.5
 Total Output Wattage (W): 16.5
 Dimming: Electronic Low Voltage Dimming to 20%
 Input Voltage (V): 120

LED

Color Temperature (°K): 3000 / 4000
 Max. Delivered Lumen (lm): 735 / 765
 Nominal Lumen (lm): 1550 / 1610
 CRI: >80 CRI
 Lamp Life (hrs): 60000

OPTICAL

Optic°: 114
 Beam Angle: Wide

RATINGS AND CERTIFICATIONS

Certified By: Certified for North American Standards
 IP rating: IP65
 IK Rating: IK08
 Bug Rating: B0 U0 G0
 Upon Request: Higher Maximum Ambient Temperature

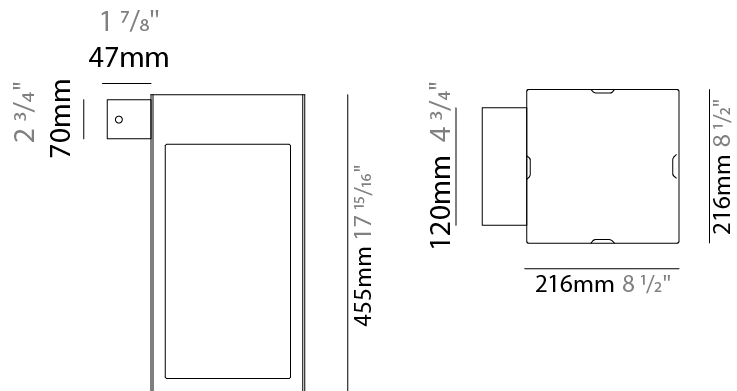

E9W609-

PROJECT

TYPE

SPECIFIER

QUANTITY

DATE

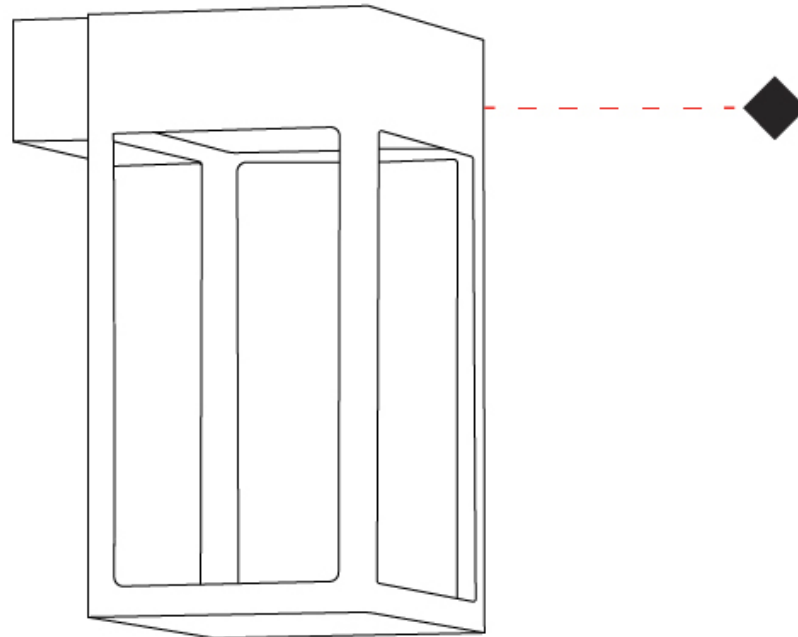

E

PROJECT _____

TYPE _____

SPECIFIER _____

QUANTITY _____

DATE _____

Fixture Finish

White - WHI



Anthracite - ANT

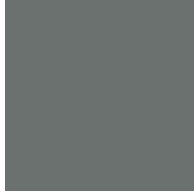

Corten - COR



Black - BLK



Bronze - BRZ

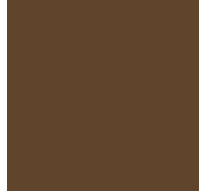

Holder Finish

Digital: Not all screens are calibrated the same, and therefore, colors will appear differently between screens.

Physical: When texture is involved, there will be variations in color, character and tone within a product series and between product families.



LEGEND

| | | | | | |
|--|---|---|--|---|--|
|  | floor-mounted |  | pivotal |  | special LED (upon request) RGB, RGBW, tunable, gold+, meat+, art+, fashion+ |
|  | wall and ceiling: recessed and surface mounted |  | rotating |  | warm dim / natural dimming LED |
|  | ceiling-mounted and wall-mounted |  | illuminate tilted |  | rechargeable battery powered |
|  | wall-mounted |  | color of suspension cable |  | fixture with natural vivid LED (upon request) |
|  | omni-directional light distribution |  | length of suspension cable |  | color rendering index |
|  | direct light distribution |  | reflector degree selection |  | color temperature |
|  | direct/indirect light distribution |  | super spot |  | lumen (luminous flux) |
|  | indirect light distribution |  | lens |  | efficacy (lumens per watt) |
|  | asymmetric light distribution |  | lens pack |  | Unified Glare Rating (UGR) range from 5-40 |
|  | aura light distribution |  | shine ring |  | marine grade (AISI 316 stainless steel) |
|  | round wall or ceiling cut-out |  | integrated shine ring with diffuser |  | walk on |
|  | square wall or ceiling cut-out |  | free individual colors 01-29 |  | drive on |
|  | the supplied jig specifies the cutout dimensions |  | individual colors: 00 (free of charge), 01-25 (extra charge) |  | Dark Sky Compliance |
|  | minimum distance (meters) lamp - object |  | luminaire part to be colored (F1) |  | Americans with Disabilities Act (less than 4" off the wall located between 27"-84" from floor) |
|  | recessed depth |  | luminaire part to be colored (F2) |  | lamp protected against explosion |
|  | ceiling thickness in mm |  | luminaire part to be colored (F3) |  | blown glass using traditional methods by master glass blower |
|  | ceiling thickness selection |  | luminaire part to be colored (F4) |  | acoustic material |
|  | dimnable DP (phase), DV (0-10V), DD (dali), DS (step-dim) |  | luminaire part to be colored (F5) |  | protection class I, protection insulation |
|  | included or excluded LED driver/transformer/control gear |  | color of 3-circuit adaptor |  | protection class II, protection insulation |
|  | separately switchable |  | indirect diffuser |  | ETL Certified to UL and CSA Standards |
|  | sensor |  | direct diffuser |  | UL Certified to UL and CSA Standards |
|  | remote control |  | ball-proof (upon request) |  | CSA Certified to UL and CSA Standards |
|  | available upon request |  | accessory |  | Certified for North American Standards |

IP RATING

| | |
|---|--|
|  | protected against ingress of solid bodies greater than 12.5mm (finger) |
|  | protected against ingress of solid bodies greater than 2.5mm protected against sprays of water up to 60 degrees from the vertical (rain) |
|  | protected against ingress of solid bodies greater than 1mm (wire) no protection against the ingress of moisture |
|  | protected against ingress of solid bodies greater than 1mm (wire) protected against sprays of water up to 60 degrees from the vertical (rain) |
|  | protected against ingress of solid bodies greater than 1mm (wire) protected against water splashed from all directions |
|  | protected against limited ingress of dust (wet rooms/covered outdoor areas) protected against water splashed from all directions |
|  | protected against ingress of dust protected against jets of water |
|  | protected against ingress of dust protected against powerful jets of water or heavy seas |
|  | protected against ingress of dust protected against immersion of water between 15cm - 1m for 30 minutes |
|  | protected against ingress of dust protected against immersion of water under pressure for long periods |

IK RATING

| | |
|---|---|
|  | protected against 0.14 joules impact (equivalent to 0.25kg mass dropped from 56mm above the surface) |
|  | protected against 0.2 joules impact (equivalent to 0.25kg mass dropped from 80mm above the surface) |
|  | protected against 0.35 joules impact (equivalent to 0.25kg mass dropped from 140mm above the surface) |
|  | protected against 0.5 joules impact (equivalent to 0.25kg mass dropped from 200mm above the surface) |
|  | protected against 0.7 joules impact (equivalent to 0.25kg mass dropped from 280mm above the surface) |
|  | protected against 1 joules impact (equivalent to 0.25kg mass dropped from 400mm above the surface) |
|  | protected against 2 joules impact (equivalent to 0.5kg mass dropped from 400mm above the surface) |
|  | protected against 5 joules impact (equivalent to 1.7kg mass dropped from 300mm above the surface) |
|  | protected against 10 joules impact (equivalent to 5.0kg mass dropped from 200mm above the surface) |
|  | protected against 20 joules impact (equivalent to 5.0kg mass dropped from 400mm above the surface) |